

# Applications



Reichstags-Kuppel, Berlin



Print Media Academy, Heidelberg

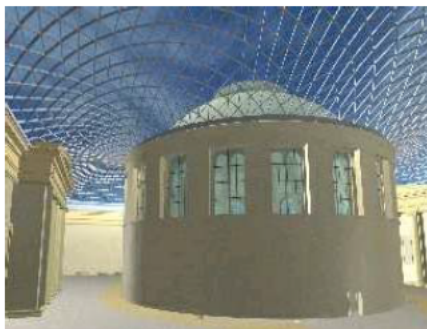
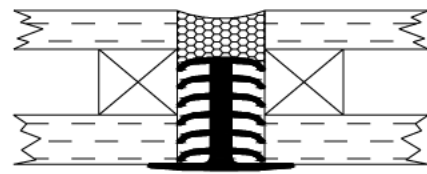

British Museum, London

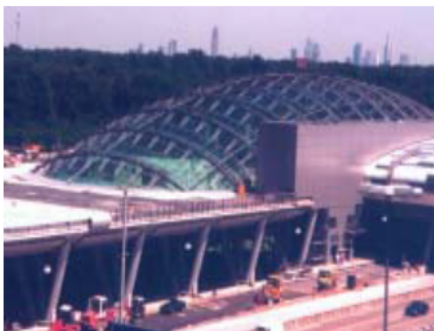
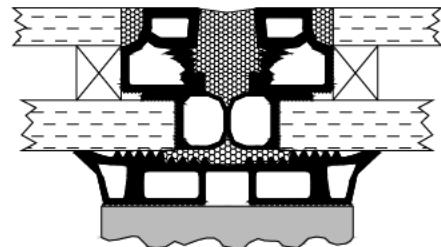

Fernbahnhof, Frankfurt/M Flughafen



Einkaufs-Passage, Rotterdam





Galeria Kaufhof, Chemnitz



Citty Hall, London



Geteshead, England

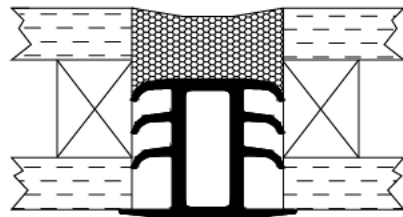

Zlote Tarasy, Warschau

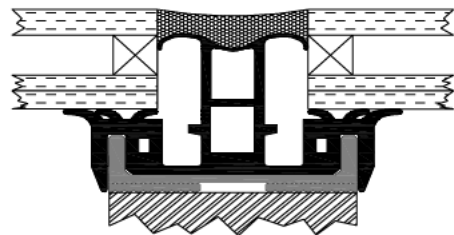

DS4, London

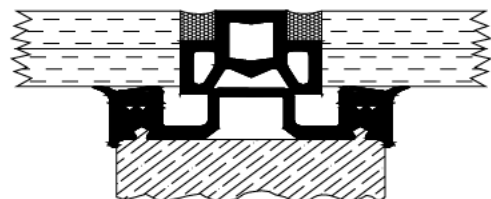



Bayer AG, Leverkusen



Swiss Re, London

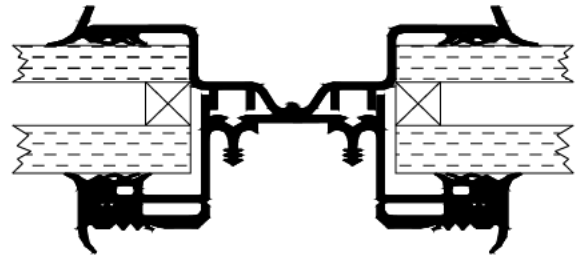

Red Bull Hangar, Salzburg

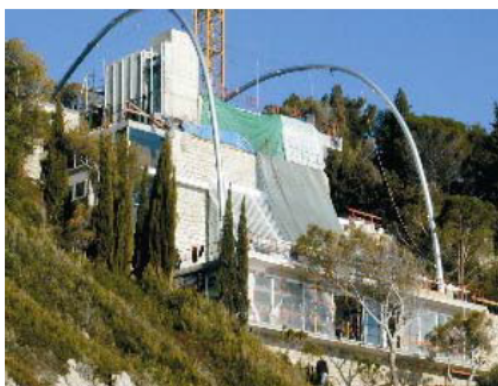

Villa Messidor, Cannes

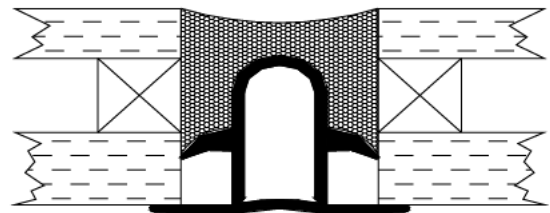

Sony Center, Berlin

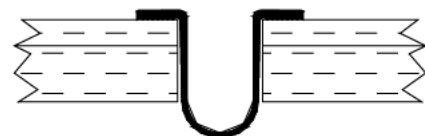



Tower Place, London

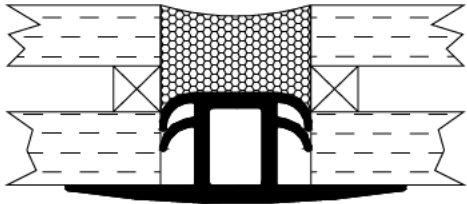

Kunstmuseum, Straßburg



Central Libarry, Seattle



## Schematically graphs of silicon glass joints sealing

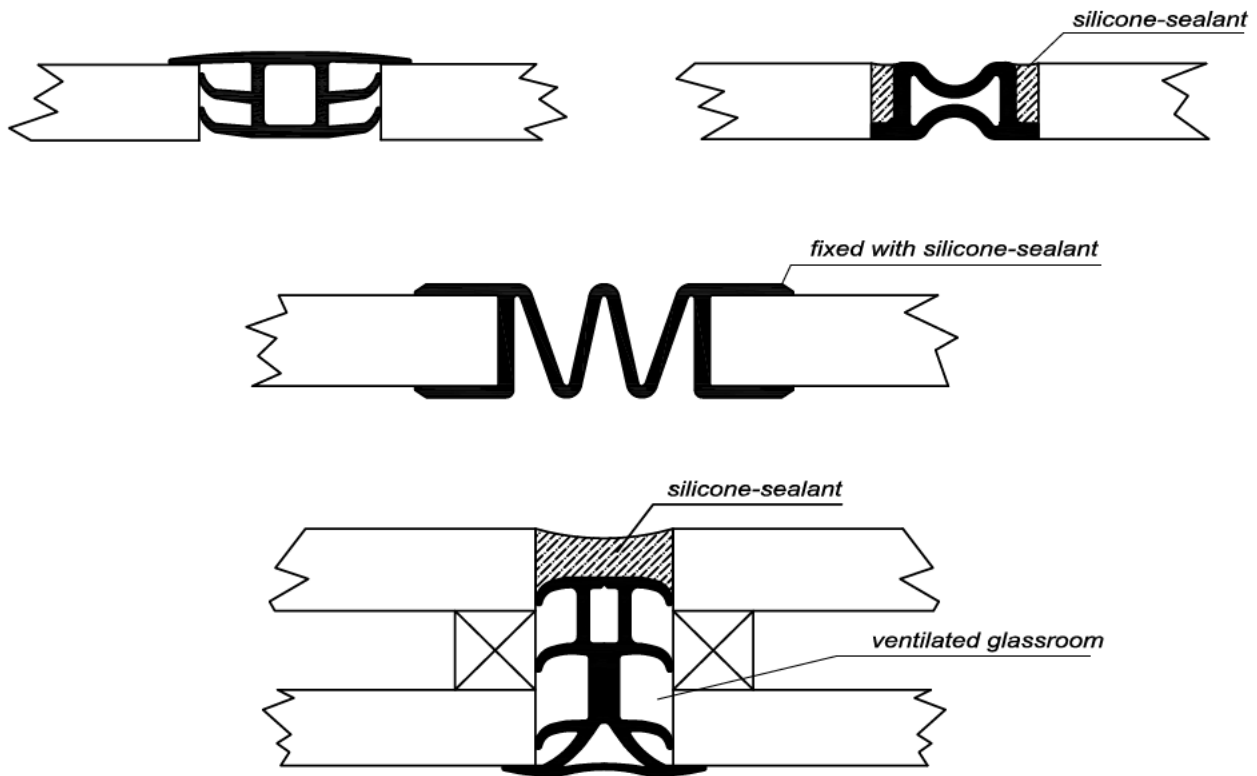

### Advantage of the Silicon-Profile-Technology

- you can combine silicon gaskets and fluid-silicon (sealant)
- available in any colour
- excellent weathering resistance and UV-stability

## Example glass to glass joints

example 1:

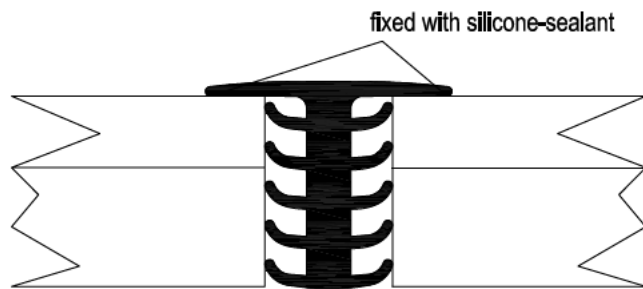

example 2:

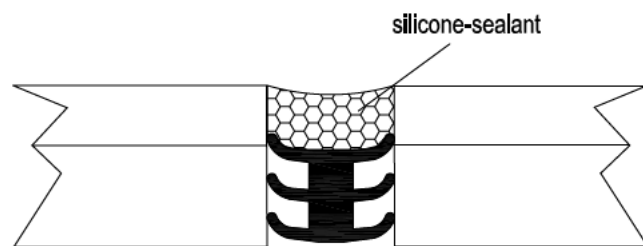

example 3:

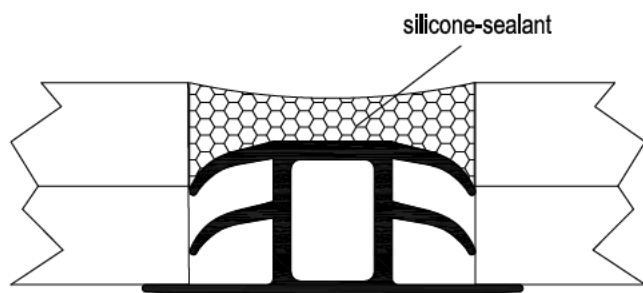

example 4:



## glass to glass joints examples

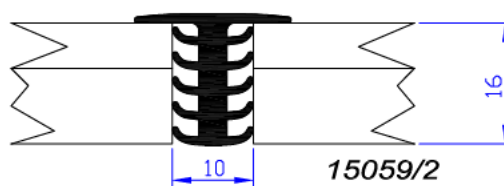
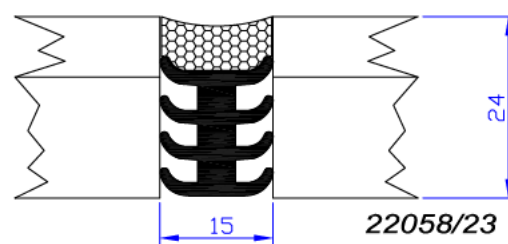
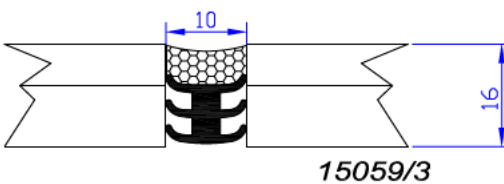
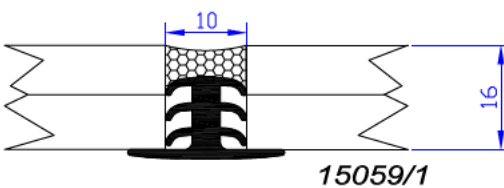
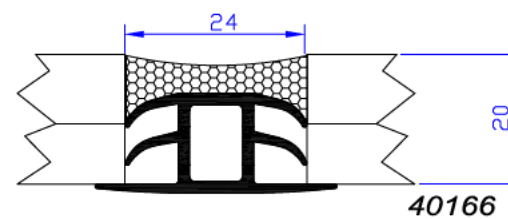
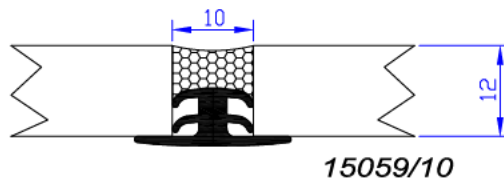
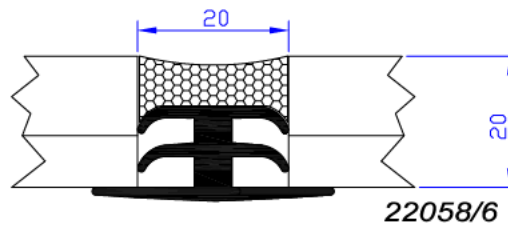
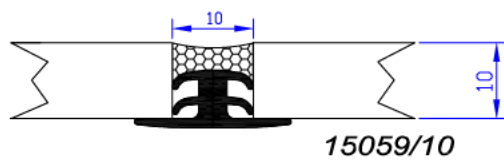
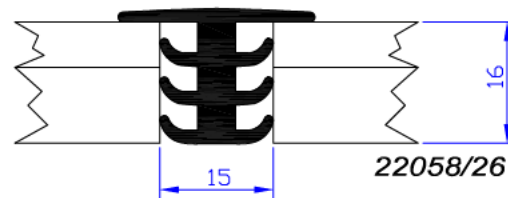
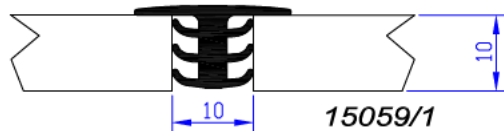
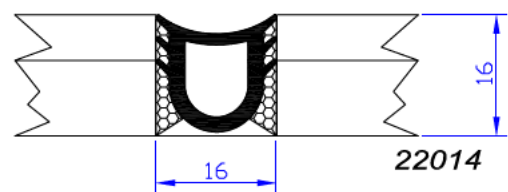
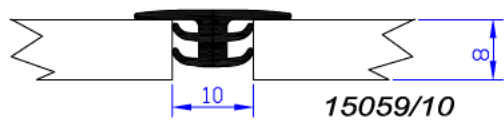

## *glass to glass joints examples*

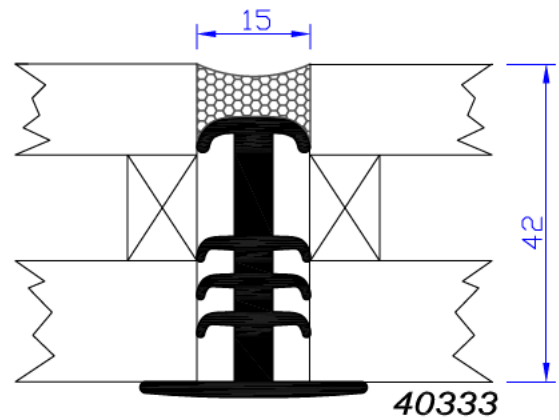
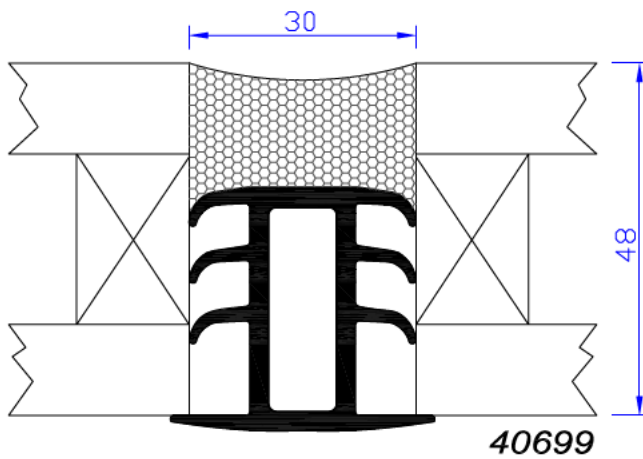
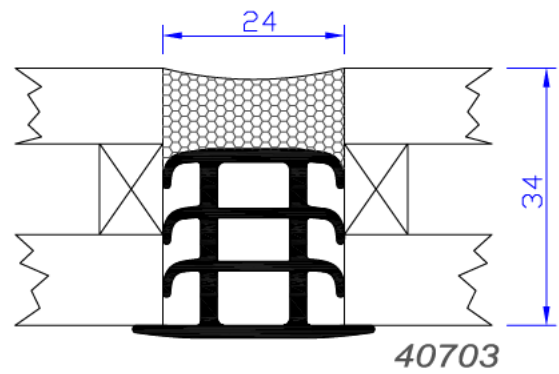
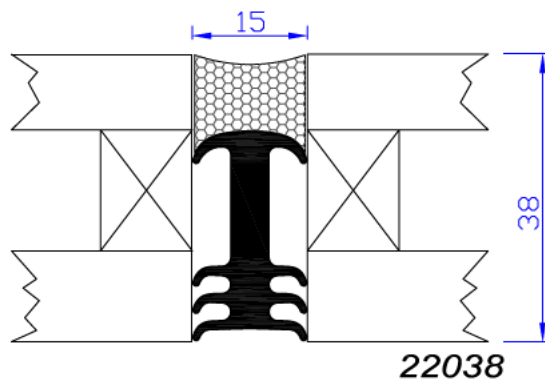
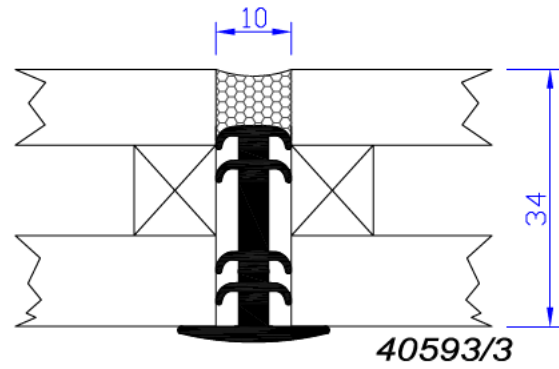
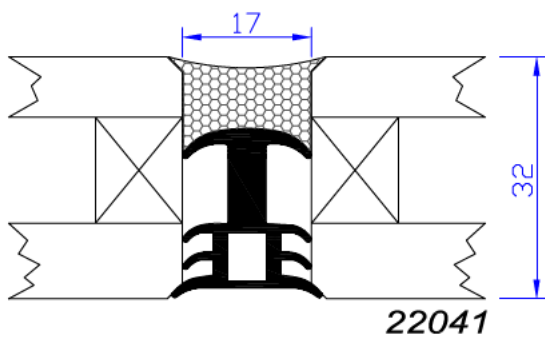



*glass to glass joints*  
*examples*  
*for insulating glass with non UV-stable glass edge*

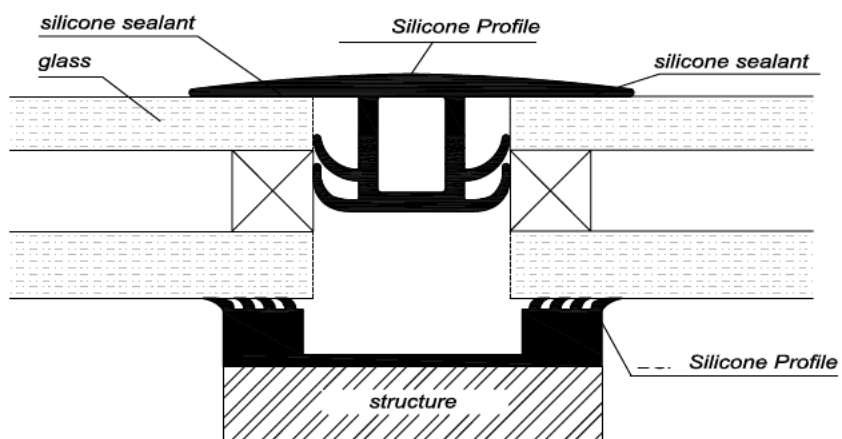
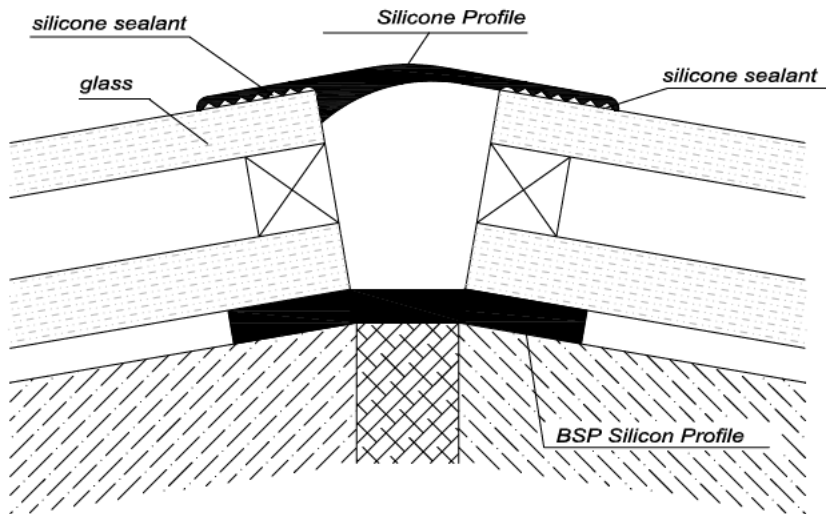
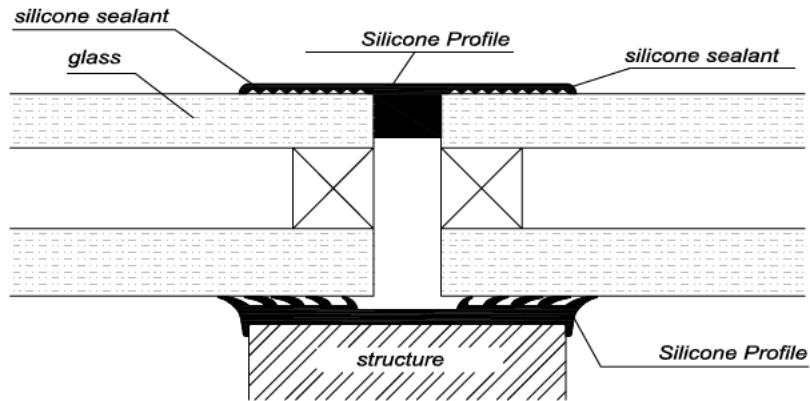

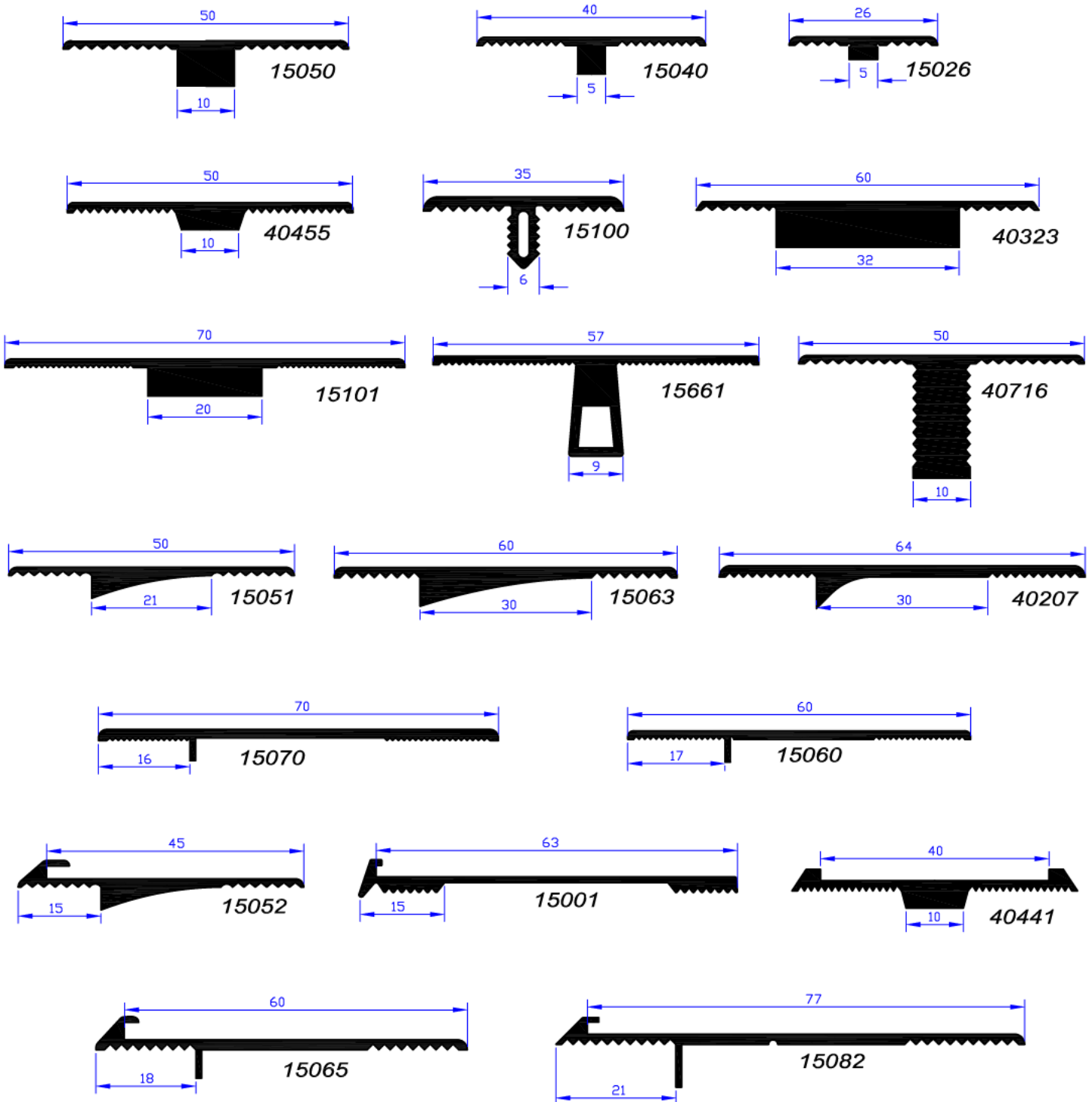

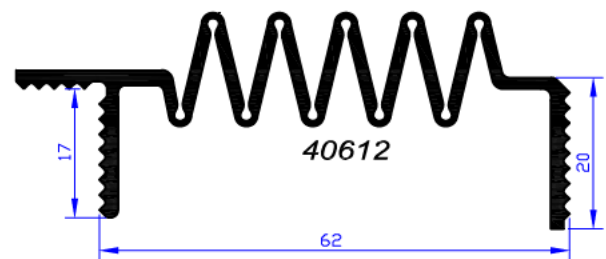
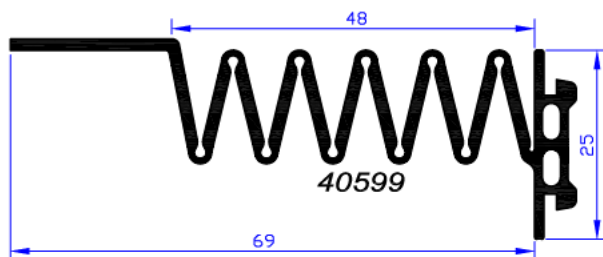
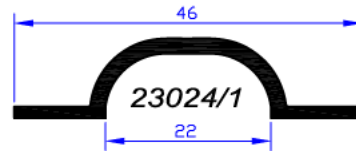
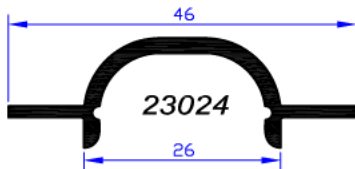
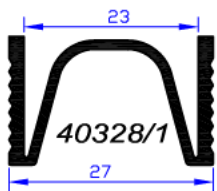
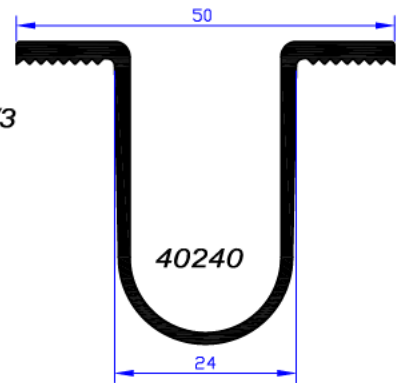
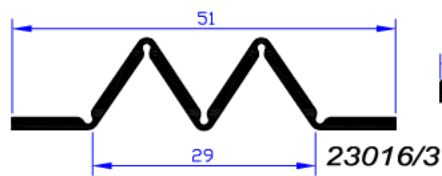
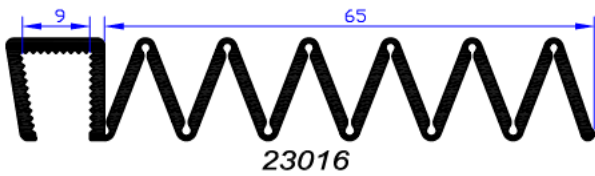
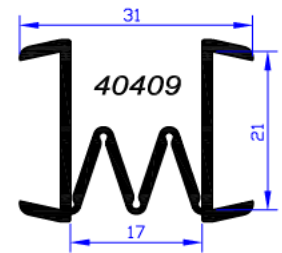
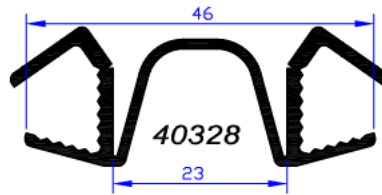
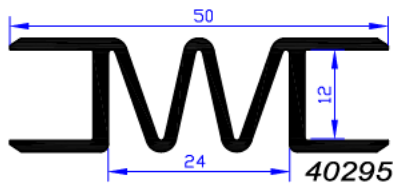
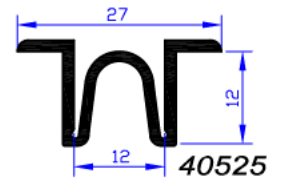
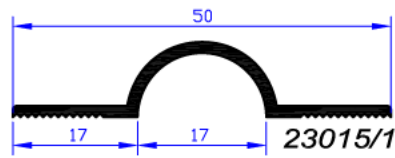
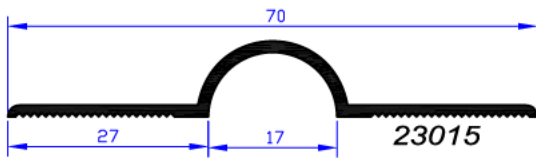
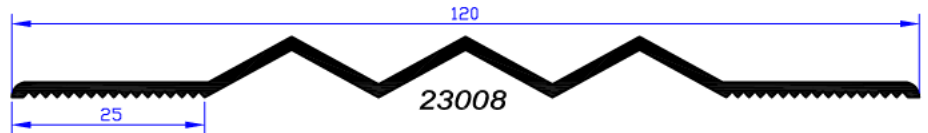
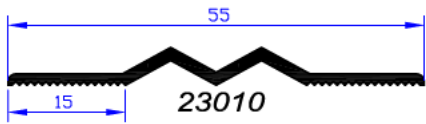

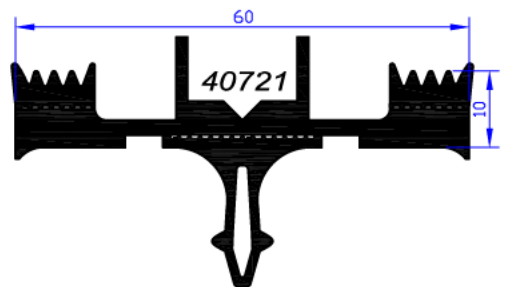
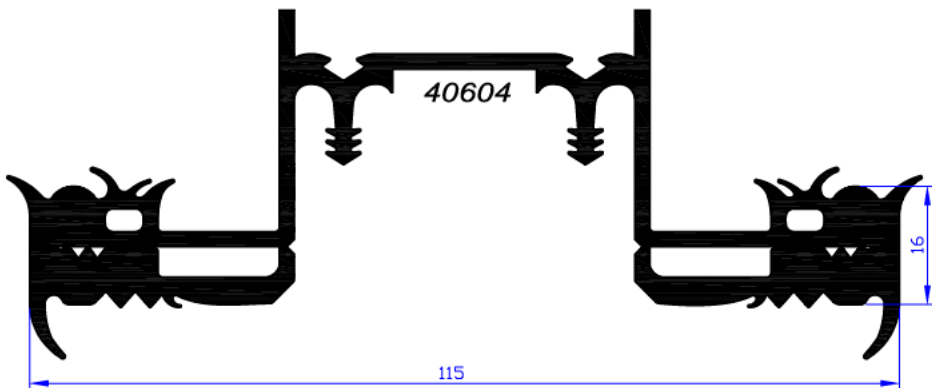
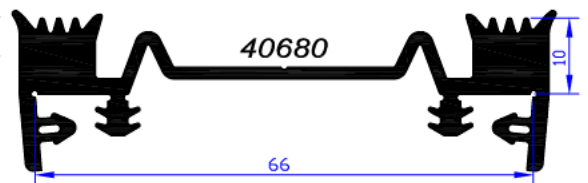
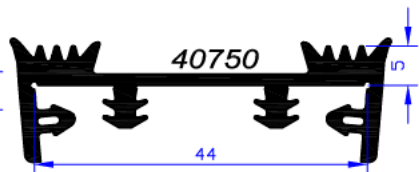
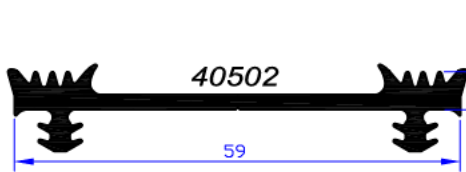
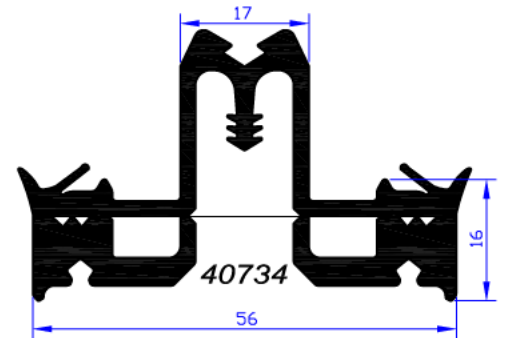
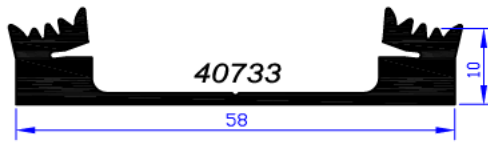
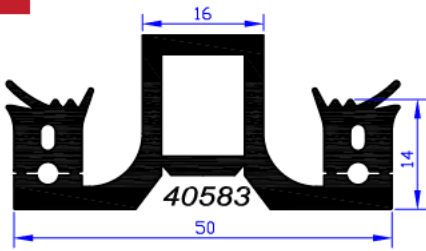
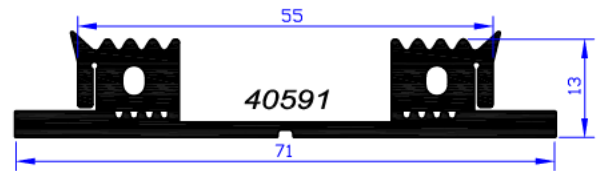
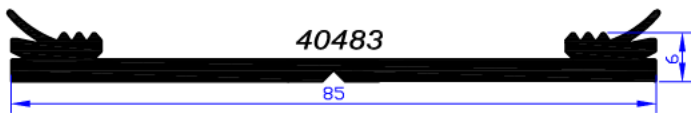
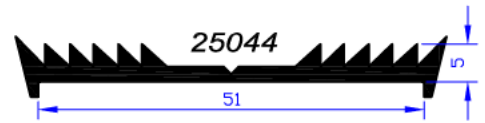
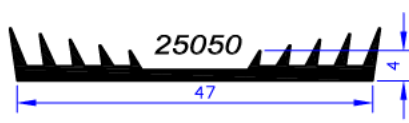
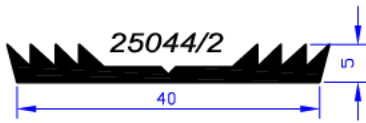
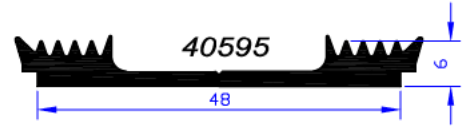
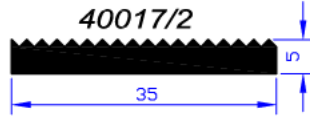
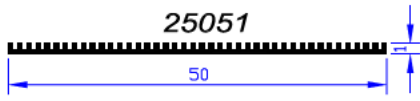

## silicone joint-tapes

25 m rolls

11030 30 x 1,5 mm



11040 40 x 1,5 mm



11050 50 x 1,5 mm



11060 60 x 1,5 mm



11070 70 x 1,5 mm



11080 80 x 1,5 mm



11090 90 x 1,5 mm



11100 100 x 1,5 mm



11120 120 x 1,5 mm



11140 140 x 1,5 mm



11160 160 x 1,5 mm



1180 180 x 1,5 mm



200 200 x 1,5 mm



## Facade joint - redevelopment with silicone tapes

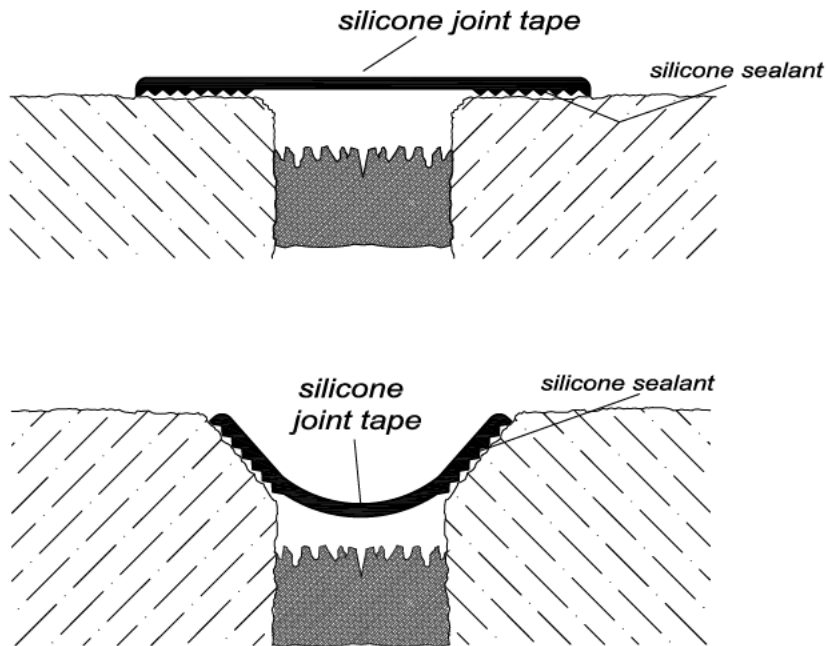

## Connection of buildings with silicone joint tapes

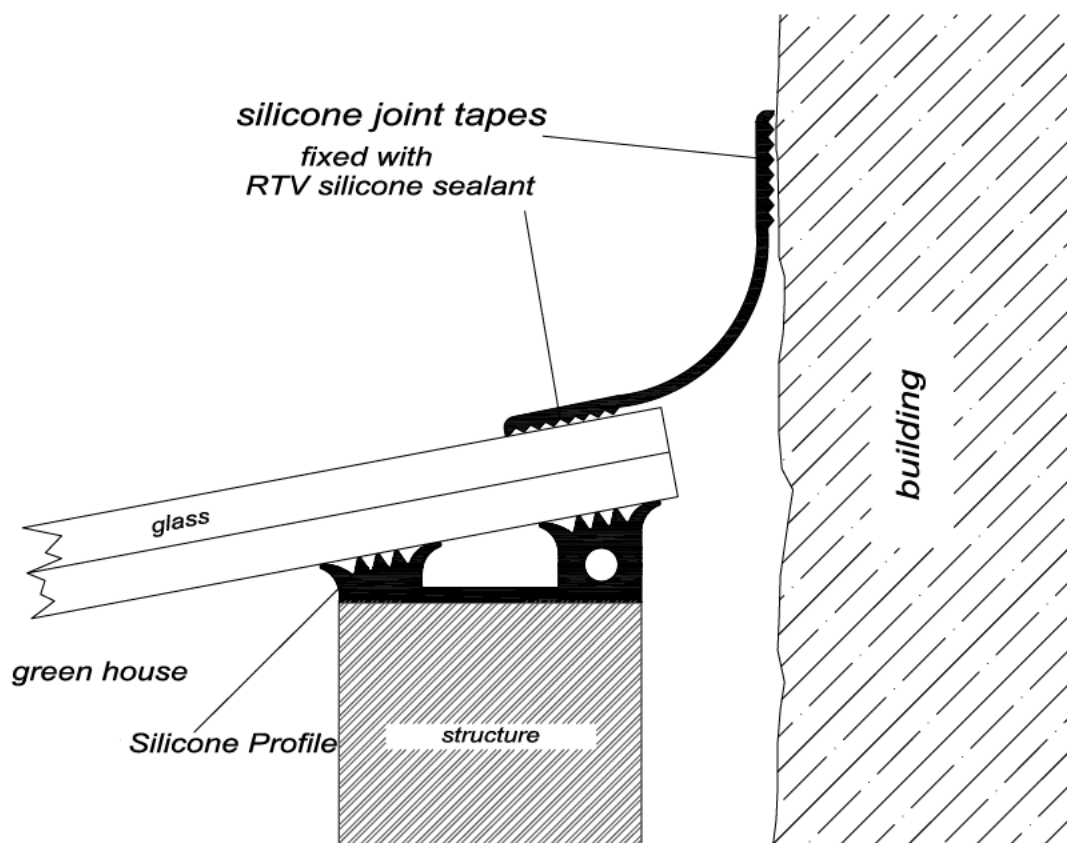

## Glass roof redevelopment with silicone joint tapes

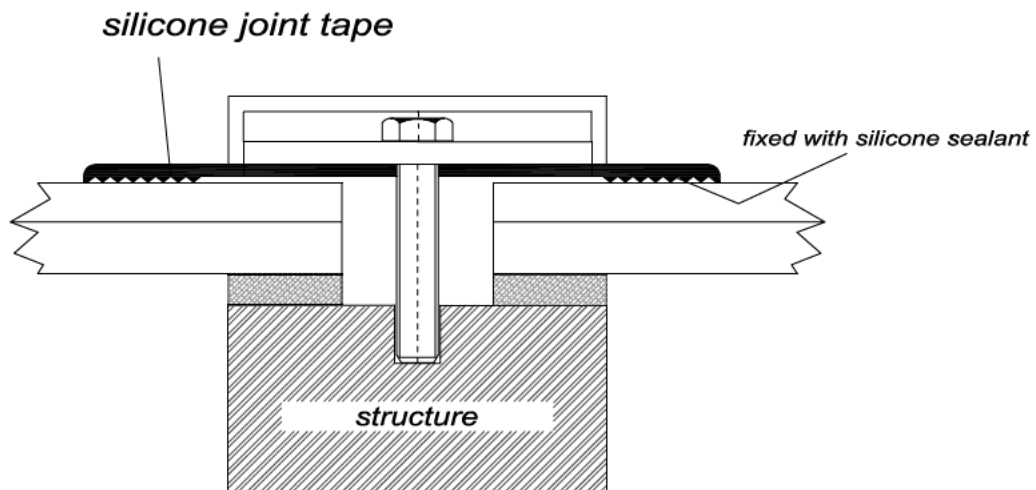
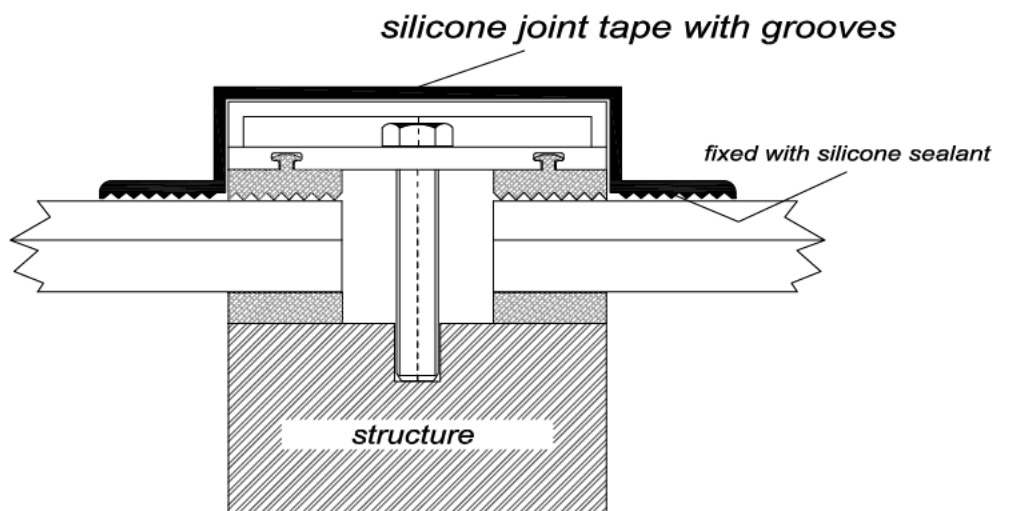

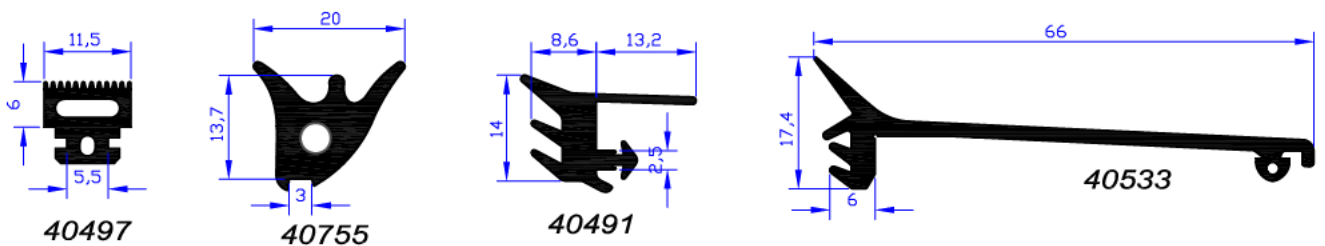
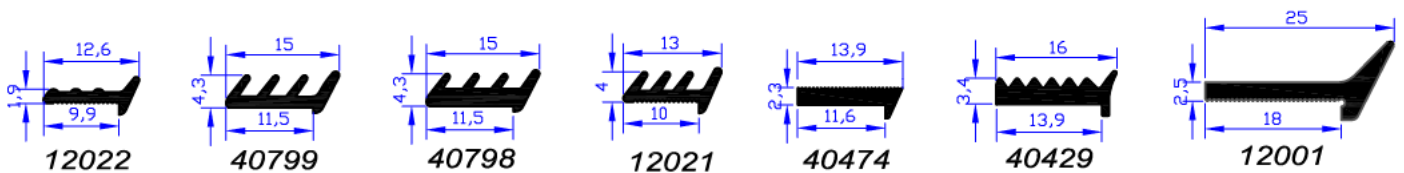
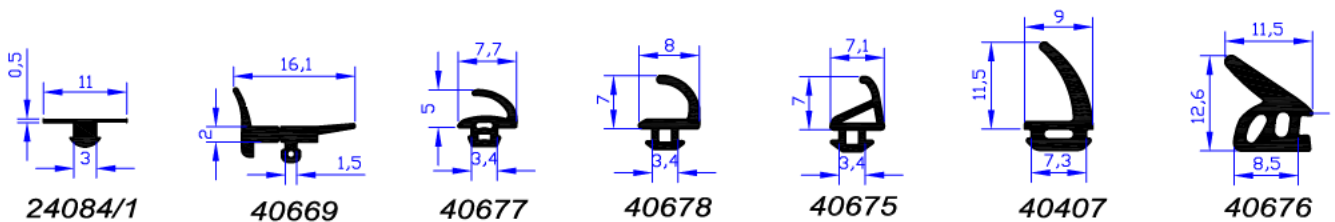
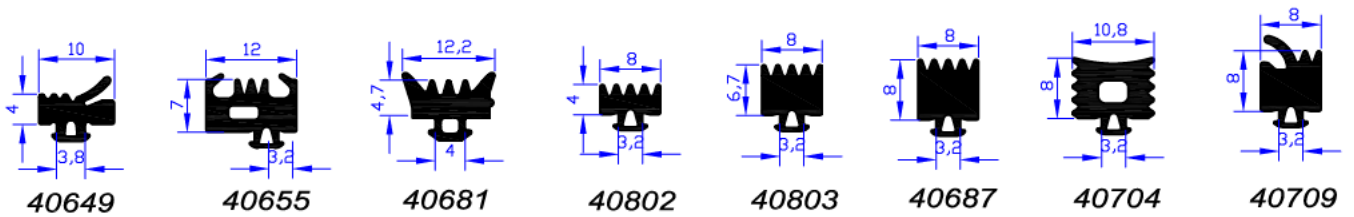
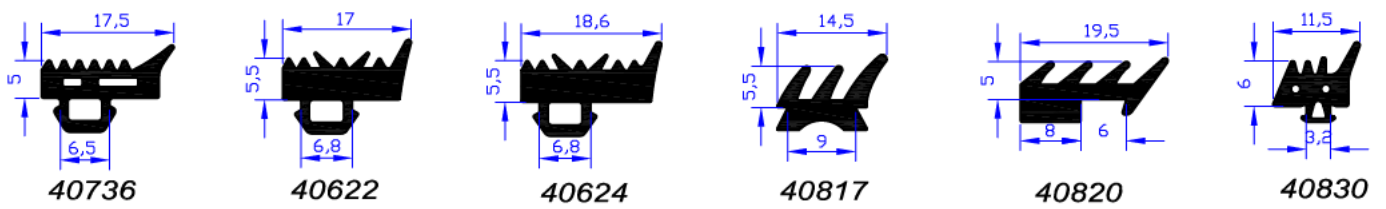
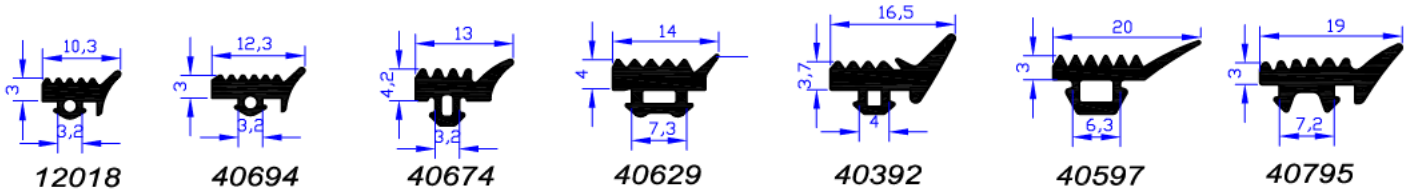





## renovation gaskets for windows

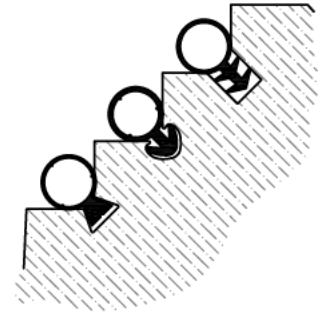

<i>height:</i>	<i>joint breadth:</i>	<i>packing:</i>
6 mm	3,0 mm	100 m/Rolle
6,5 mm	3,0 mm	100 m/Rolle
8 mm	3,0 mm	100 m/Rolle
11 mm	3,0 mm	100 m/Rolle



6 mm	Ankerfräser	100 m/Rolle
8 mm	Ankerfräser	100 m/Rolle
10 mm	Ankerfräser	100 m/Rolle



6 mm	Schwabenschwanzfräser	100 m/Rolle
7,5 mm	Schwabenschwanzfräser	100 m/Rolle
8 mm	Schwabenschwanzfräser	100 m/Rolle
10 mm	Schwabenschwanzfräser	100 m/Rolle



5 mm	3,0 mm	100 m/Rolle
------	--------	-------------



10 mm	1,5 mm	100 m/Rolle
-------	--------	-------------



10 mm	Ankerfräser	100 m/Rolle
-------	-------------	-------------

## renovation gaskets for windows



*height:*

*6 mm*

*8 mm*

*12 mm*

*packing:*

*100 m/Rolle*

*100 m/Rolle*

*100 m/Rolle*



*6 mm*

*100 m/Rolle*



*6 mm*

*100 m/Rolle*

*8 mm*

*100 m/Rolle*

*10 mm*

*100 m/Rolle*



*10 mm*

*100 m/Rolle*



*6,5 mm*

*100 m/Rolle*

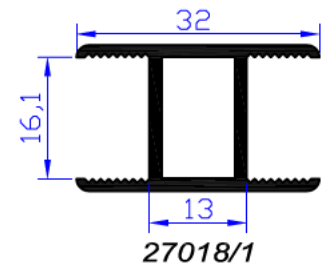
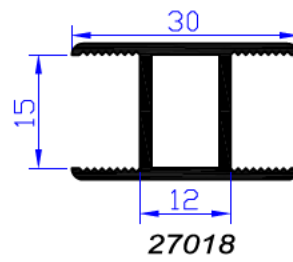
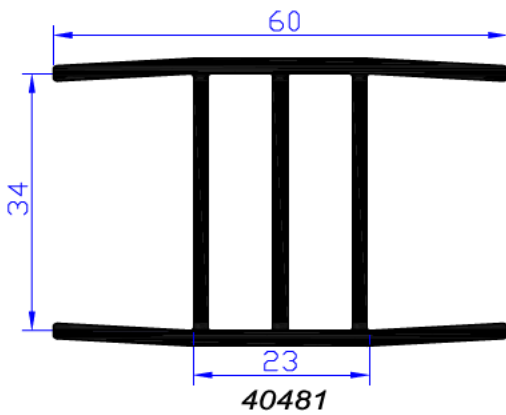
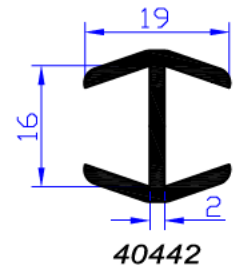
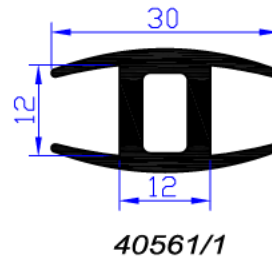
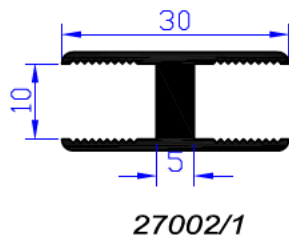
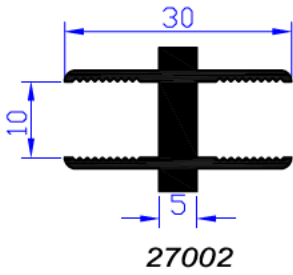
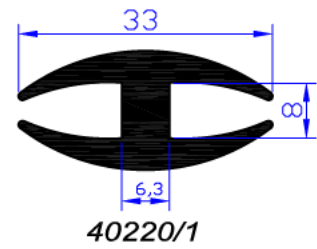
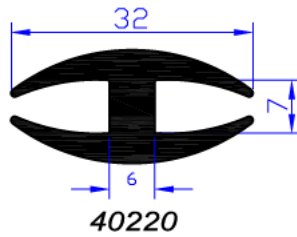
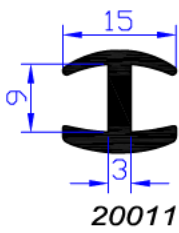
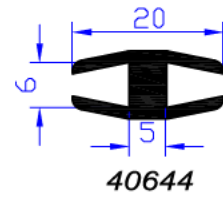
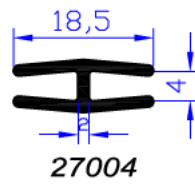
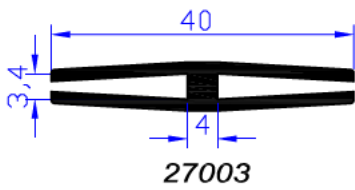

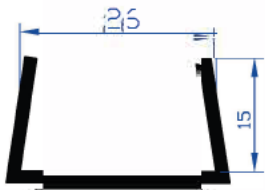

29058

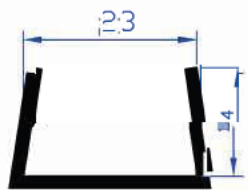

29058/1

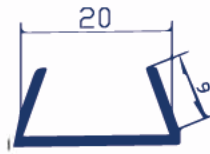

40401

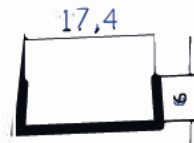

40744



40397

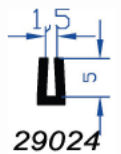

29024



29004

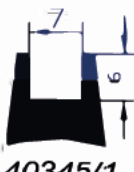

40345/1

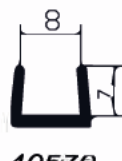

40570

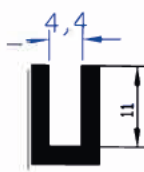

29026/1

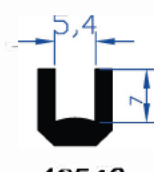

40546

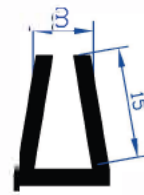

40216

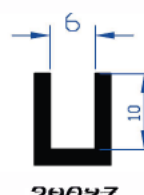

29027

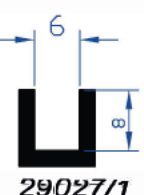

29027/1

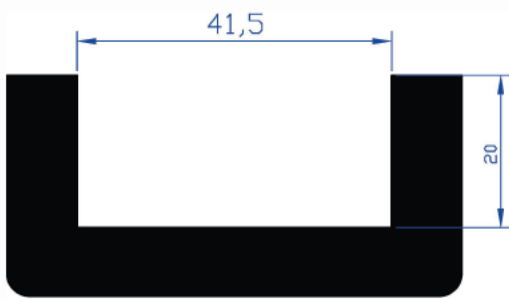

40266

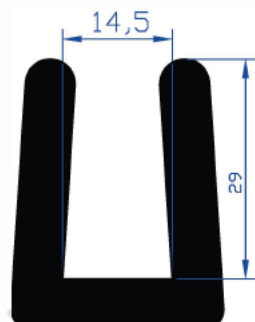

40423

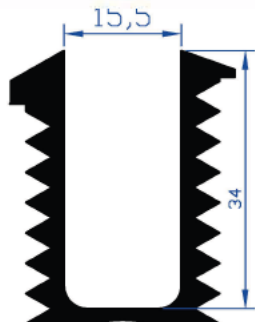

40697

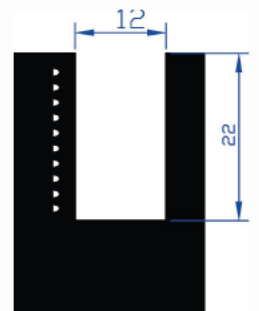

40417

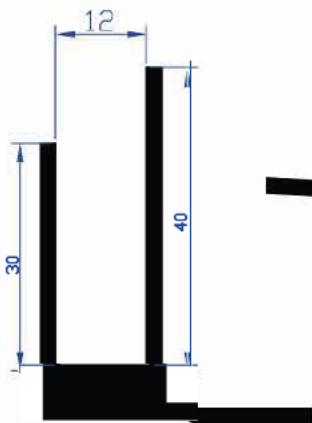

40575

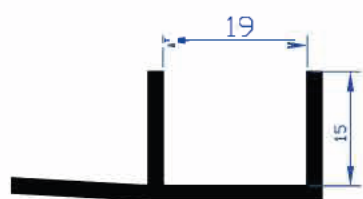

40481/2

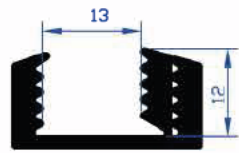

40784

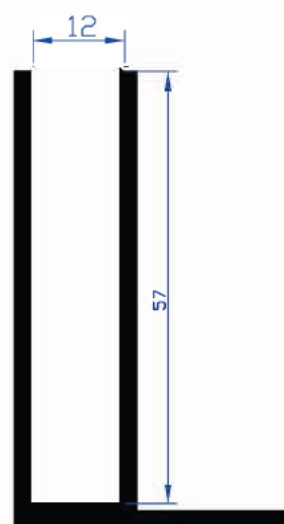

40637

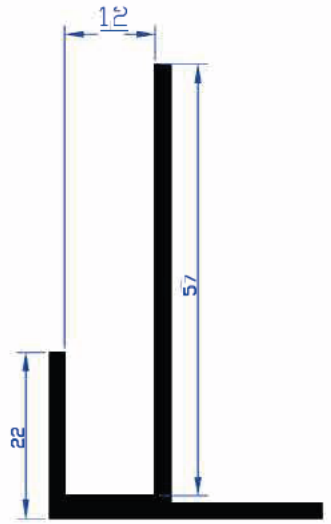

40637/1

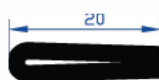

21007

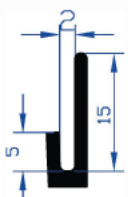

29034/1

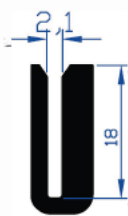

40618

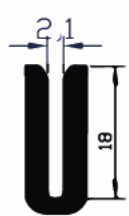

40617



40662

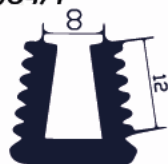

40776



40711

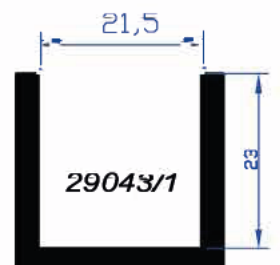

29043/1

